

MADE IN ITALY
SINCE 1920

 **Rinieri**



POTATRICI - PRUNER MACHINES - TAILLEUSE
SCHNEIDEGERÄT - PODADORAS



CRF - ORPL - ORP - ORSL - ORS
www.rinieri.com





3 - 4 cm
(1,2 - 1,6")

MONOLAMA / SICKLE BAR / MONOLAME / EINZELKLINGE / MONOLAMA



 Potatrice per meleti e frutteti ad alta densità ideale per il taglio di rami in impianti a spalliera con altezze delle piante fino 4m. Le barre di taglio monolama con denti "SCH" sono in grado di tagliare rami Ø 3-4 cm. Per adattare la macchina a qualsiasi esigenza di impianto sono disponibili una serie di accessori come top superiore e inferiori. In particolare negli impianti con reti antigrandine il top superiore può essere dotato di inclinazione idraulica e rotazione posteriore idraulica per scansare i pali. La macchina può essere comandata da un joystick proporzionale con fino a 6 movimenti più accensione motori.

 New high density-spindle orchard pruner suitable in all kind of varieties like apples, apricots, cherries, olives until 4m (13') high of the trees. The single acting sickle bar with "SCH" teeth can work with branches up to Ø 3-4 cm (1,2"-1,6"). To adapt the machine to all kinds of orchards are available a number of accessories like top bars or bottom bars. In particular, in orchards with hail nets the top bar can be equipped with hydraulic tilting and hydraulic rear rotation to avoid the poles. On request it is also available a "window" cutting kit with max 3 bars that makes lightening inside the canopy ensuring better penetration of sunlight. This produces an increase in productivity inside the trees. This kit also reduces the hand labor almost completely during the pruning.

 Outil de taille pour pommaraies et vergers à haute densité. La machine est idéale pour le coupe de branches dans des implantations en espallier avec une hauteur des plantes jusqu'à 4 mètres. Les barres de coupe monolame avec dents "SCH" sont à même de couper des branches jusqu'à Ø 3-4 cm. Pour adapter la machine à n'importe quelle exigence, l'on peut employer des accessoires supplémentaires comme le top supérieur et inférieur. En particulier, dans les implantations avec filets paragrêle, le top supérieur peut être doué d'inclinaison hydraulique et rotation postérieure hydraulique pour esquivar les poteaux. La machine peut être commandée par un joystick proportionnelle avec jusqu'à 6 mouvements plus allumage moteurs.

 Schneidegerät für Apfel- und andere Obstplantagen mit hoher Dichte, ideal für den Schnitt der Äste von Spalierobst bis zu einer Pflanzenhöhe von 4m. Die Schneidwerke mit „SCH“-Fingern und Klingen schneiden bis zu einem Durchmesser von 3-4cm. Um die Maschine an die Anforderungen verschiedener Anlagen anzupassen, stehen eine Reihe von Zubehören wie obere und untere Schneidwerke zur Verfügung. Speziell für Anlagen mit Hagelnetzen kann das obere Schneidwerk mit hydraulischer Neigungsverstellung und Heckrotation ausgestattet werden um den Pfählen auszuweichen. Die Maschine kann mit einem proportionalen Joystick mit 6 Bewegungen und Motoreinschaltung gesteuert werden.

 Nueva podadora para huertas de alta densidad y árboles frutales ideal para el corte de ramas de plantas en espaldera con alturas de hasta 4 m. Las barras de corte alternativo con dientes "SCH" pueden trabajar con ramas Ø 3-4 cm. Para adaptar la máquina para todo los tipos de cultivos están disponibles una serie de accesorios, como la barra superior y inferior. En particular, en los sistemas con las redes antigranizo la barra de corte superior puede ir equipada con inclinación hidráulica y rotación trasera para esquivar los rodrigones. La máquina puede ser controlada por un joystick proporcional de hasta 6 movimientos mas encendido motores.

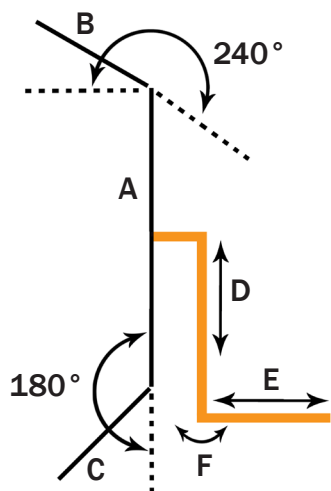

A cm (inch)	B cm (inch)	C cm (inch)	D cm (inch)	E cm (inch)	F
250 (98") 280 (110")	120 (47")	70 (28")	60 (24")	40 (16")	+20° -20°
l/min (gpm)	bar (psi)	rpm	Kg (lbs)	ton	
30 - 40 (8 - 11)	80 (1150)	300	300 - 500 (660 - 1100)	2 - 3	



Lama e dente "SCH"
"SCH" blades and teeth
Lame et dent "SCH"
Klinge und "SCH" Messer
Hoja y diente "SCH"



Top superiore con inclinazione e rotazione idraulica
Top cutting bar with hydraulic tilting and rotation
Top supérieur avec inclinaison et rotation hydraulique
Obermesserbalken mit hydr. Neigung und Drehung
Tope superior con inclinación y rotación hidráulicas



Carrello
Stand
Support
Ständer
Cavallette



Barra inferiore con molla antiurto
Lower cutting bar with spring safety
Barre inférieure avec ressort antishock
Unterschnittmesser mit Stoßsicherungseinzug
Barra inferior con muelle anti-golpe



Biella ammortizzata
Push rod with springs
Bielle amortie
Gedämpftes Pleuel
Biela con amortiguador



Joystick proporzionale
Proportional joystick
Joystick proportionel
Proportionaler Joystick
Joystick proporcional





3 - 4 cm
(1,2 - 1,6")

MONOLAMA / SICKLE BAR / MONOLAME / EINZELKLINGE / MONOLAMA



 Potatrice per frutteti in grado di lavorare su diverse forme di allevamento, sia tradizionale con impianto monocono o cono, sia intensivo dedicato alla raccolta meccanizzata. Il telaio è dotato di 4 movimenti idraulici comandati da un joystick proporzionale e può montare 1 o 2 barre monolama con denti "SCH" in grado di tagliare rami Ø cm 3-4. La macchina, dotata di due barre di taglio, effettua la potatura verticale ed orizzontale in un solo passaggio. Per un corretto funzionamento è necessaria una portata di olio di 30-40 l/min. non è quindi necessaria l'adozione di una centralina idraulica indipendente.

 The orchard pruner is suitable in different type of cultivation like cone and mono-cone or high density for machine harvesting. The frame has 4 hydraulic movements acting by a proportional joystick and it can mount 1 or 2 bars with single acting sickle bar with "SCH" teeth which work with branches up to Ø cm 3-4 (1,2"-1,6"). The machine with 2 bars cuts the side and the top in the same time. In order to operate needs a oil flow of 30-40 l/min (8-11 gpm).

 Outil de taille approprié pour vergers. Conseillé pour travaux dans différentes formes de cultures, à la fois traditionnelle avec une implantation cône ou mono-cône ou intensive dédiée à la récolte mécanisée. Le châssis est doué de 4 mouvements hydrauliques contrôlés par un joystick proportionnel et peut monter 1 ou 2 barres mono-lame avec dents "SCH" qui sont à même de couper des branches jusqu'à Ø 3-4 cm. La machine, douée de deux barres de coupe, exécute la taille verticale et horizontale en une seule étape. Pour un bon fonctionnement, la machine nécessite d'un débit d'huile de 30/40 litres/min, par conséquent il ne faut pas employer un système hydraulique indépendant.

 Baumschneider für jeden Obstplantagentyp mit verschiedenen Wuchsformen, sowohl traditionell für Einzelkegelplantagen oder Kegelplantagen, als auch für intensive Anlagen für die mechanisierte Ernte. Der Rahmen hat 4 hydraulische Bewegungen und wird durch einen proportionalen Joystick gesteuert. Das Gerät besteht aus ein oder zwei einreihigen Schneidwerken mit "SCH"-Fingern für den Schnitt von Ästen bis zu Ø 3-4 cm. Die Version mit zwei Schneidwerken kann in einem einzigen Arbeitsgang sowohl den vertikalen als auch den horizontalen Baumschnitt durchführen. Für einen korrekten Betrieb, braucht die Maschine 30-40 l/min Hydraulikleistung und ist so nicht auf ein zusätzliches unabhängiges Hydraulikaggregat angewiesen.

 La prepodadora de arboles puede trabajar en diferentes tipos de cultivo, tanto cono o monocono tradicional, como huerta intensiva para cosecha mecanizada. El chasis está equipado con 4 movimientos hidráulicos controlados por un joystick proporcional de fácil manejo y se puede equipar con 1 o 2 barras de corte alternativo para cortar ramas Ø cm 3-4. La máquina que dispone de dos barras puede cortar verticalmente y horizontalmente en una sola pasada y requiere un flujo de aceite de 30-40 l/min para trabajar correctamente. Por tanto no es necesario adoptar una central hidráulica independiente.

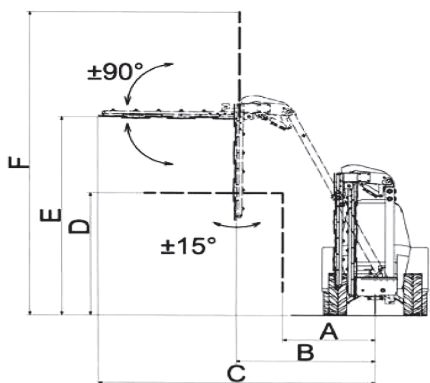

MOD	A cm (inch)	B cm (inch)	C cm (inch)	D cm (inch)	E cm (inch)	F cm (inch)
ORPL 210+150	130 (51)	250 (98)	390 (154)	220 (87)	400 (157)	540 (212)
ORPL 210+210	130 (51)	250 (98)	450 (177)	220 (87)	400 (157)	600 (236)

	G cm (inch)	H cm (inch)	 l/min (gpm)	 bar (psi)	 rpm	 Kg (lbs)	 ton
ORPL 210+150	210 (83)	150 (59)	40 (11)	80 (1150)	300	400 (880)	2,5
ORPL 210+210	210 (83)	210 (83)	40 (11)	80 (1150)	300	420 (925)	2,8



Biella
Push rod
Bielle
Pleuel
Biela



Lama e dente "SCH"
"SCH" blade and tooth
Lame et dent "SCH"
Klinge und "SCH" Messer
Hoja y diente "SCH"



Joystick proporzionale
Proportional joystick
Joystick proportionel
Proportionaler Joystick
Joystick proporcional



Carrello
Stand
Support
Ständer
Cavallette





10 cm
(4")

DISCHI / DISCS / DISQUES / SHEIBEN / DISCOS



 Potatrice per frutteti in grado di lavorare su diverse forme di allevamento, sia tradizionale con impianto monocono o cono sia intensivo dedicato alla raccolta meccanizzata. Il telaio è dotato di 4 movimenti idraulici comandati da un joystick proporzionale e può montare 1 o 2 barre a dischi in acciaio in grado di tagliare rami Ø cm 8-10. La macchina dotata di due barre di taglio effettua la potatura verticale ed orizzontale in un solo passaggio. Di serie è fornita completa di una centralina idraulica con radiatore di raffreddamento olio che garantisce la giusta portata alle barre di taglio.

 The orchard pruner is suitable in different types of cultivation like cone and mono-cone or high density for machine harvesting. The frame has 4 hydraulic movements acting by a proportional joystick and it can mount 1 or 2 saw discs bars which works with branches up to Ø cm 8-10 (3-4"). The machine with 2 bars cuts the side and the top in the same time. It is supplied standard with a independent hydraulic kit with oil cooler which provides the right oil flow for the cutting bars.

 Outil de taille approprié pour vergers. Conseillé pour travaux dans différentes formes de cultures, à la fois traditionnelles avec une implantation cône ou mono-cône ou intensive dédiée à la récolte mécanisée. Le châssis est doté de 4 mouvements hydraulique contrôlés par un joystick proportionnel et peut monter 1 ou 2 barres à disques en acier qui sont à même de couper des branches jusqu'à Ø 8-10 cm. La machine dotée de deux barres de coupe exécute la taille vertical et horizontal en une seule étape. Elle est équipée en standard par une central hydraulique avec radiateur de refroidissement pour l'huile qui garantit le débit d'huile correct aux barres de coupe.

 Baumschneider für jeden Obstplantagentyp mit verschiedenen Wuchsformen, sowohl traditionell für Einzelkegelplantagen oder Kegelplantagen, als auch für intensive Anlagen für die mechanisierte Ernte. Der Rahmen hat 4 hydraulische Bewegungen und wird durch einen proportionalen Joystick gesteuert. Das Gerät besteht aus ein oder zwei Schneidwerken mit Kreissägen aus Stahl für den Schnitt von Ästen bis zu Ø 8-10 cm. Die Version mit zwei Schneidwerken kann in einem einzigen Arbeitsgang sowohl den vertikalen als auch den horizontalen Baumschnitt durchführen. Die Maschine hat serienmäßig ein Hydraulikaggregat mit Ölkühler, das die korrekte Hydraulikleistung für die einwandfreie Funktion der Schneidwerke gewährleistet.

 La prepodadora de arboles puede trabajar en diferentes tipos de cultivo, tanto cono o monocono tradicional, como huerta intensiva para cosecha mecanizada. El chasis está equipado con 4 movimientos hidráulicos controlados por un joystick proporcional de fácil manejo y se puede equipar con 1 o 2 módulos de corte con discos de acero para cortar ramas Ø cm 8-10. La máquina que dispone de dos barras puede cortar verticalmente y horizontalmente en una sola pasada y se completa con una central hidráulica con el radiador de refrigeración de aceite que garantiza el flujo adecuado para las barras de corte.

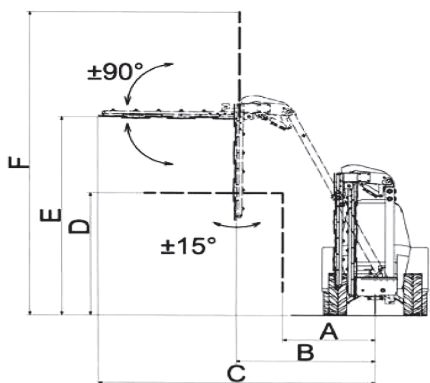

MOD	A cm (inch)	B cm (inch)	C cm (inch)	D cm (inch)	E cm (inch)	F cm (inch)
ORP 6+4	130 (51)	250 (98)	390 (154)	220 (87)	400 (157)	540 (212)
ORP 6+6	130 (51)	250 (98)	450 (177)	220 (87)	400 (157)	600 (236)

	G cm (inch)	H cm (inch)				
			Ø cm (inch)	rpm	Kg (lbs)	ton
ORP 6+4	200 (79)	140 (55)	40 (16)	2800	400 (880)	3
ORP 6+6	200 (79)	200 (79)	40 (16)	2800	420 (925)	3



Particolare snodo idraulico del top
Support with hydraulic tilting for top bar
Support avec articulation hydraulique du top
Stütze fuer Balken mit Neigungsverstellung
Empalme hidraulico especial del tope



Centralina idraulica
Hydraulic kit
Centrale hydraulique
Hydraulikanlage
Centralita hidráulica



Joystick proporzionale
Proportional joystick
Joystick proportionel
Proportionaler Joystick
Joystick proporcional



Carrello
Stand
Support
Ständer
Cavallette





6 cm
(2,4")

MONOLAMA / SICKLE BAR / MONOLAME / EINZELKLINGE / MONOLAMA



 Potatrice da frutteto con telaio con spostamento a parallelogramma adatto a frutteti tradizionali con altezze fino a 6m. La barra di taglio singola con dente e lama "Rinieri" permette di lavorare con rami fino a 6cm di Ø. Il telaio con spostamento a parallelogramma permette di settare l'angolo di taglio una sola volta, questo rimarrà il medesimo durante il lavoro, anche se vengono utilizzati gli altri spostamenti. I comandi sono a joystick proporzionale. La macchina può essere utilizzata in frutteti tradizionali a vaso come ulivo, pesco, susino e anche in deforestazione lungo strade o campi.

 Orchard pruner with frame with parallelogram side shift suitable for traditional orchard with high max of 6m. The sickle-cutting bar with heavy-duty "Rinieri" teeth and blades works with branches up to 6 cm. The frame with parallelogram side shift permits of setting the angle of cut one time, and it does not change even if the other movements are used. A proportional joystick controls the machine. This machine can be used in traditional orchard "V" type like olives, peaches, plum and along the roads or field.

 Tailleuse pour vergers avec châssis avec déplacement à parallélogramme idéal pour vergers avec hauteurs jusqu'à 6 m. La barre de coupe single avec dent et lame «Rinieri» permet de travailler des branches jusqu'à 6 cm. Le châssis avec déplacement à parallélogramme permet de régler l'angle de coupe une fois seulement, et il restera le même pendant le travail même si on utilise les autres déplacements. Les commandes sont à joystick proportionnel. Cette machine peut être utilisée dans les vergers traditionnelles à forme de «V» comme des olives, pêches, et pour la déforestation le long des routes ou des champs.

 Baumschneider für traditionelle Obstplantaten bis zu einer Baumhöhe von 6m mit Parallelogramm-Rahmen. Das "Rinieri"-Klingenschneidwerk mit Klingensreihe und Fingern erlaubt den Schnitt von Ästen bis zu einem Durchmesser von 6 cm. Der Parallelogramm-Rahmen erlaubt es, den Schnittwinkel nur einmal einzustellen, sodass er nicht angepasst werden muss wenn während der Arbeit die anderen Bewegungen der Maschine verwendet werden. Die Steuerung erfolgt mittels proportionalem Joystick. Die Maschine ist geeignet für traditionelle Obstplantagen mit Y-Form wie Oliven, Pfirsiche oder Pflaumen sowie für die Entwaldung entlang von Straßen oder Feldern.

 Podadora para frutales con bastidor con desplazamiento de paralelogramo ideal para cultivos tradicionales con altura de hasta 6 m. La barra de corte con diente y hoja "Rinieri" permite trabajar con ramas de hasta 6 cm. El bastidor con desplazamiento de paralelogramo permite colocar el ángulo de corte una sola vez, y esto quedará el mismo durante el trabajo aunque se utilicen los otros movimientos. Los mandos son a través de joystick proporcional. Esta máquina puede ser utilizada en huertas frutales tradicionales a vaso como olivos, melocotón, ciruelo y también para deforestación.

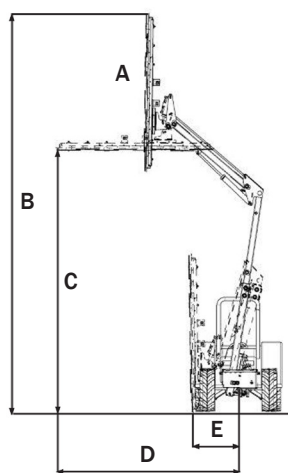

MOD	A cm (inch)	B cm (inch)	C cm (inch)	D cm (inch)	E cm (inch)
ORSL 250	250 (98)	630 (248)	460 (181)	350 (138)	100 (39)
ORSL 280	280 (110)	660 (260)	460 (181)	380 (150)	100 (39)
ORSL 300	300 (118)	680 (268)	460 (181)	400 (157)	100 (39)

MOD	rpm	Kg (lbs)	ton
ORSL 250	200	580 (1280)	3,5
ORSL 280	200	605 (1330)	3,5
ORSL 300	200	630 (1390)	4



Centralina idraulica
Hydraulic kit
Centrale hydraulique
Hydraulikanlage
Centralita hidráulica

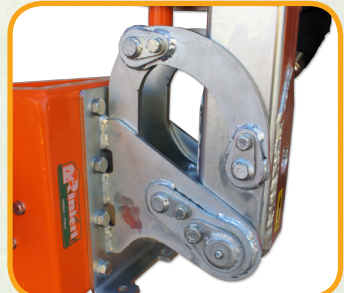

Angolazione barra 215°
Tilting cutting bar 215°
Angulation barre 215°
Drehung Schneidwerk 215°
Angulación barra 215°



Lama e dente RINIERI
RINIERI blades and teeth
Lame et dent RINIERI
Klinge und RINIERI Messer
Hoja y diente RINIERI



Joystick proporzionale
Proportional joystick
Joystick proportionel
Proportionaler Joystick
Joystick proporcional





Carrello
Stand
Support
Ständer
Cavallette





10 cm
(4")

DISCHI / DISCS / DISQUES / SHEIBEN / DISCOS

 Potatrice a dischi da frutteto con telaio con spostamento a parallelogramma adatto a frutteti tradizionali con altezze fino a 6m. Abbiamo a disposizione due tipologie di barre di taglio, la standard con dischi da 40cm Ø per il taglio fino ad un massimo di 10cm oppure la versione rinforzata, con dischi da 60cm, per il taglio di rami da 15cm di Ø. Il telaio con spostamento a parallelogramma permette di settare l'angolo di taglio una sola volta, questo rimarrà il medesimo durante il lavoro, anche se vengono utilizzati gli altri spostamenti. I comandi sono a joystick proporzionale. La macchina può essere utilizzata in frutteti tradizionali a vasetto come ulivo, pesco, susino e anche in deforestazione lungo strade o campi.

 Orchard pruner with saw discs and frame with parallelogram side shift suitable for traditional orchard with high max of 6m. We have available two type of cutting bar, the standard one with 40cm disc that cut up to 10cm branches and the heavy-duty one with 60cm disc that cut up to 15cm branches. The frame with parallelogram side shift permits of setting the angle of cut one time, and it does not change even if the other movements are used. A proportional joystick controls the machine. This machine can be used in traditional orchard "V" type like olives, peaches, plum and along the roads or field.

 Tailleuse à disques pour vergers avec châssis avec déplacement à parallélogramme appropriée à vergers traditionnelles avec hauteur jusqu'à 6 m. Deux types de barres de coupe sont à disposition, la standard avec disques de 40 cm de diamètre pour le coupe jusqu'à 10cm max ou le modèle renforcé avec disques de 60 cm pour le coupe de branches de 15 cm. Le châssis avec déplacement à parallélogramme permet de régler l'angle de coupe une fois seulement, et il restera le même pendant le travail même si on utilise les autres déplacements. Les commandes sont à joystick proportionnel. Cette machine peut être utilisée dans les vergers traditionnelles à forme de «V» comme des olives, pêches, et pour la déforestation le long des routes ou des champs.

 Baumschneider für Obstplantagen mit Parallelogramm-Rahmen und Schneidwerk mit Kreissägen für Baumhöhen bis zu 6m. Es stehen zwei Modelle von Schneidwerken zur Verfügung: das Standardschneidwerk mit Kreissägen zu 40cm Durchmesser für Äste bis maximal 10cm Durchmesser oder das verstärkte Schneidwerk mit Kreissägen zu 60cm Durchmesser für Äste bis maximal 15 cm Durchmesser. Der Parallelogramm-Rahmen erlaubt es, den Schnittwinkel nur einmal einzustellen, sodass er nicht angepasst werden muss wenn während der Arbeit die anderen Bewegungen der Maschine verwendet werden. Die Steuerung erfolgt mittels proportionalem Joystick. Die Maschine ist geeignet für traditionelle Obstplantagen mit Y-Form wie Oliven, Pfirsiche oder Pflaumen sowie für die Entwaldung entlang von Straßen oder Feldern.

 Podadora de discos para frutales con bastidor con desplazamiento de paralelogramo ideal para frutales tradicionales con altura de hasta 6m. Disponibles dos tipos de barras de corte, la estandar con discos de 40cm de diametro para cortes de hasta 10cm maximo, o la versión reforzada con discos de 60cm para el corte de ramas de hasta 15cm. El bastidor con desplazamiento de paralelogramo pemite colocar el angulo de corte una sola vez, y esto quedará el mismo durante el trabajo aunque se utilizen los otros movimimientos. Los mandos son a través de joystick proporcional. Esta maquina puede ser utilizada en huertas frutales tradicionales a vaso como olivos, melocotón, ciruelo y tambien para deforestación.



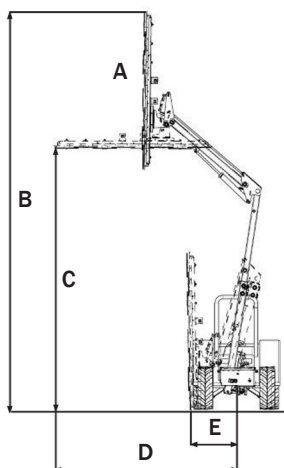

MOD	A cm (inch)	B cm (inch)	C cm (inch)	D cm (inch)	E cm (inch)
ORS 7	235 (92)	615 (242)	460 (181)	335 (132)	100 (39)
ORS 8	270 (106)	650 (256)	460 (181)	370 (146)	100 (39)
ORSX 5	275 (108)	655 (258)	460 (181)	375 (148)	100 (39)

MOD	Ø cm (inch)	rpm	Kg (lbs)	ton
ORS 7	40 (16)	2800	580 (1280)	3,5
ORS 8	40 (16)	2800	605 (1330)	3,5
ORSX 5	60 (24)	1800	680 (1500)	4



Angolazione barra 215°
Tilting cutting bar 215°
Angulation barre 215°
Drehung Schneidwerk 215°
Angulación barra 215°



Centralina idraulica
Hydraulic kit
Centrale hydraulique
Hydraulikanlage
Centralita hidráulica



Joystick proporzionale
Proportional joystick
Joystick proportionel
Proportionaler Joystick
Joystick proporcional



Carrello
Stand
Support
Ständer
Cavallette

CRF2





3 - 4 cm
(1,2 - 1,6")

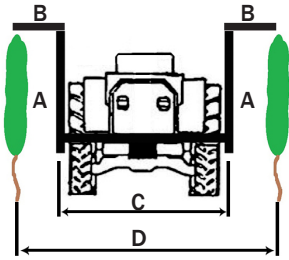

MONOLAMA / SICKLE BAR / MONOLAME / EINZELKLINGE / MONOLAMA



MOD	A cm (inch)	B cm (inch)	C cm (inch)	D cm (inch)	 l/min (gpm)	 Kg (lbs)	 ton
CRF2 250	250 (98)	120 (47)	150 - 300 (59 - 118)	230 - 400 (90 - 157)	40 - 50 (11 - 13)	580 (1280)	4
CRF2 280	280 (110)	120 (47)	150 - 300 (59 - 118)	230 - 400 (90 - 157)	40 - 50 (11 - 13)	605 (1340)	4

www.rinieri.com



Viale dell'Appennino 606B
47121 - Forlì (FC) - ITALY
Tel. +39 0543 86066
Fax +39 0543 83418

info@rinieri.com